

# BACK BAR EQUIPMENT

**Model: BBC79-SS-PT**

## 79" Back Bar Cooler, Pass-Thru

Stainless steel exterior and countertop, heavy-duty galvanized interior with reinforced stainless steel floor.

**Designed to maintain NSF-7 temperatures in 100°F ambient.**



### Options and Accessories

(upcharge and lead times may apply)

Casters or legs	Automatic, electric condensate evaporator
Textured baked black enamel finish exterior	Riser base (field installed)
Food storage rated stainless steel interior (NSF-7)	Condensing unit on right
Glass doors in lieu of solid doors	Wine rack
Add'l epoxy-coated shelves with clips	Shallow depth
Stainless steel shelves with clips	

\* Adding a Riser Base increases overall height 2"

Project Name:

Model Specified:

Location:

Item No:

Quantity:

AIA #:

SIS #:

### Standard Model Features

#### REFRIGERATION SYSTEM

- Performance-rated **front breathing** refrigeration system
- Environmentally-safe R-134a refrigerant
- Automatic, energy-saving, non-electric condensate evaporator
- Extra large, balanced evaporator coil

#### CABINET ARCHITECTURE

- High density, non-CFC polyurethane foamed-in-place insulation
- Heavy-duty epoxy-coated steel shelves
- Magnetic snap-in gasket (each door)
- Cylinder-keyed security lock (each door)
- Stainless steel reinforced threshold

#### MODEL FEATURES

- Low profile cabinet design
- Electronic controller w/ digital display & hi-low alarm
- Easily accessible and serviceable slide-out condensing unit
- Front, rear and side venting louvered grills
- Interior light

**Continental**  
Refrigerator

Toll-Free: 800-523-7138  
Phone: 215-244-1400  
Fax: 215-244-9579

539 Dunksferry Road  
Bensalem, PA 19020  
[www.continentalrefrigerator.com](http://www.continentalrefrigerator.com)

APPROVAL:

## Model Specifications

### DIMENSIONAL DATA

Net Capacity (cu. ft.)	28 (793 cu l)
Width, Overall (in.)	79 (2007 mm)
Depth, Overall (in.) (incl. handles)	31 3/8 (797 mm)
Depth, Body Only (in.) (less doors)	25 (635 mm)
Height, Overall (in.)	34 3/4 (883 mm)
Barrel Capacity (# barrel type kegs)	3
Straight Wall Capacity (# straight wall kegs)	4
No. of Doors	6
No. of Shelves	6

### REFRIGERANT DATA

Condensing Unit Size (H.P.)	1/3
Capacity (BTU/Hr)*	2500

### ELECTRICAL DATA

Voltage (int'l)	115/60/1 (220/50/1)
Feed Wires (incl. ground)	3
Total Amps (int'l)	5.33 (4.2)
10 ft. Cord/Plug [attached] (int'l)	Yes (No)

### SHIPPING DATA

Weight (lbs.)	500 (227 kg)
Height - Crated (in.)	46 (1168 mm)
Width - Crated (in.)	88 (2235 mm)
Depth - Crated (in.)	42 (1067 mm)

\* Rating @ +25°F evaporator, 90°F ambient  
 Figures in parentheses reflect metric equivalents rounded to the nearest whole unit.

## Model Plan Views

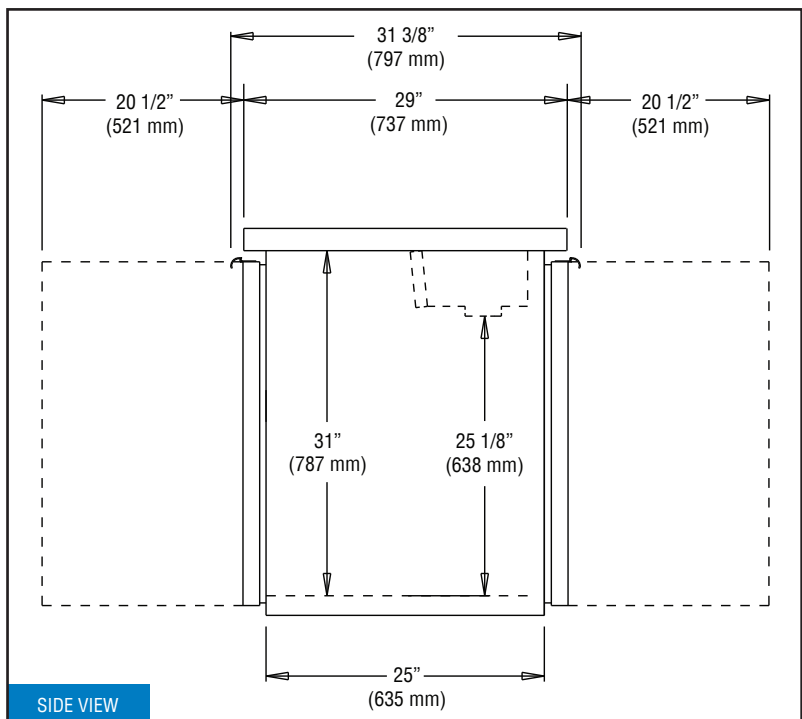
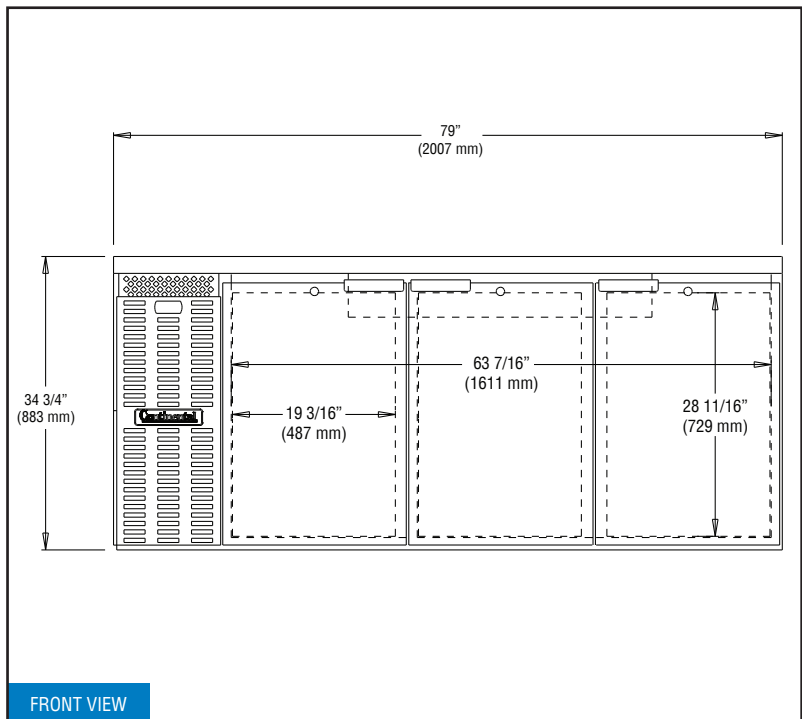

**IMPORTANT NOTE:** Models are completely front breathing and take in and exhaust air through the front grill. A clearance of 1" on the back and 3" on the sides is recommended.

**Continental**  
 Refrigerator

Toll-Free: 800-523-7138  
 Phone: 215-244-1400  
 Fax: 215-244-9579

539 Dunkserry Road  
 Bensalem, PA 19020  
[www.continentalrefrigerator.com](http://www.continentalrefrigerator.com)

Due to our continued efforts in developing innovative products, specifications subject to change without notice.



Intertek



MADE IN THE U.S.A.

© Copyright 2017. Continental Refrigerator.  
 A Division of National Refrigeration & Air Conditioning Products, Inc.