

# BACK BAR EQUIPMENT

**Model: BBC79S-PT**

## 79" Back Bar Cooler Shallow Depth, Pass-Thru

Textured baked black enamel finish exterior with all stainless steel countertop, heavy-duty galvanized interior with reinforced stainless steel floor.

**Designed to maintain NSF-7 temperatures in 100°F ambient.**



### Options and Accessories

(upcharge and lead times may apply)

Casters or legs	Automatic, electric condensate evaporator
Stainless steel exterior (-SS models)	Riser base (field installed)
Food storage rated stainless steel interior (NSF-7)	Condensing unit on right
Glass doors in lieu of solid doors	Wine rack
Add'l epoxy-coated shelves with clips	Standard depth
Stainless steel shelves with clips	

\* Adding a Riser Base increases overall height 2"

Project Name:

Model Specified:

Location:

Item No:

Quantity:

AIA #:

SIS #:

### Standard Model Features

#### REFRIGERATION SYSTEM

- Performance-rated **front breathing** refrigeration system
- Environmentally-safe R-134a refrigerant
- Automatic, energy-saving, non-electric condensate evaporator
- Extra large, balanced evaporator coil

#### CABINET ARCHITECTURE

- High density, non-CFC polyurethane foamed-in-place insulation
- Heavy-duty epoxy-coated steel shelves
- Magnetic snap-in gasket (each door)
- Cylinder-keyed security lock (each door)
- Stainless steel reinforced threshold

#### MODEL FEATURES

- Low profile cabinet design
- Electronic controller w/ digital display & hi-low alarm
- Easily accessible and serviceable slide-out condensing unit
- Front, rear and side venting louvered grills
- Interior light

**Continental**  
Refrigerator

Toll-Free: 800-523-7138  
Phone: 215-244-1400  
Fax: 215-244-9579

539 Dunksferry Road  
Bensalem, PA 19020  
[www.continentalrefrigerator.com](http://www.continentalrefrigerator.com)

APPROVAL:

## Model Specifications

### DIMENSIONAL DATA

Net Capacity (cu. ft.)	22 (623 cu l)
Width, Overall (in.)	79 (2007 mm)
Depth, Overall (in.) (incl. handles)	27 3/8 (695 mm)
Depth, Body Only (in.) (less doors)	21 (533 mm)
Height, Overall (in.)	34 3/4 (883 mm)
Barrel Capacity (# barrel type kegs)	3
Straight Wall Capacity (# straight wall kegs)	3
No. of Doors	6
No. of Shelves	6

### REFRIGERANT DATA

Condensing Unit Size (H.P.)	1/3
Capacity (BTU/Hr)*	2500

### ELECTRICAL DATA

Voltage (int'l)	115/60/1 (220/50/1)
Feed Wires (incl. ground)	3
Total Amps (int'l)	5.33 (4.2)
10 ft. Cord/Plug [attached] (int'l)	Yes (No)

### SHIPPING DATA

Weight (lbs.)	455 (206 kg)
Height - Crated (in.)	46 (1168 mm)
Width - Crated (in.)	88 (2235 mm)
Depth - Crated (in.)	42 (1067 mm)

\* Rating @ +25°F evaporator, 90°F ambient  
 Figures in parentheses reflect metric equivalents rounded to the nearest whole unit.

## Model Plan Views

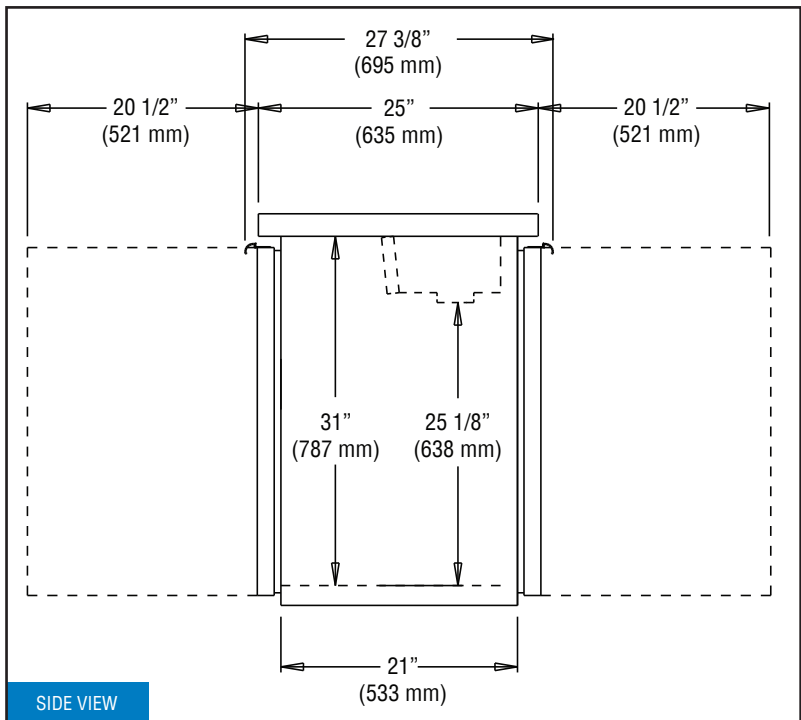
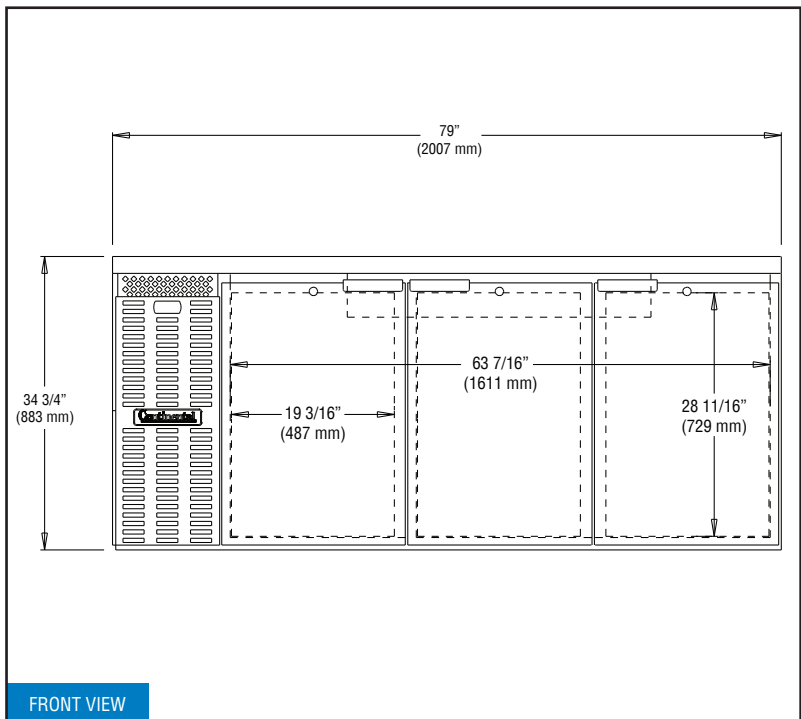

**IMPORTANT NOTE:** Models are completely front breathing and take in and exhaust air through the front grill. A clearance of 1" on the back and 3" on the sides is recommended.

**Continental**  
 Refrigerator

Toll-Free: 800-523-7138  
 Phone: 215-244-1400  
 Fax: 215-244-9579

539 Dunkserry Road  
 Bensalem, PA 19020  
[www.continentalrefrigerator.com](http://www.continentalrefrigerator.com)

Due to our continued efforts in developing innovative products, specifications subject to change without notice.



Intertek



MADE IN THE U.S.A.

© Copyright 2017. Continental Refrigerator.  
 A Division of National Refrigeration & Air Conditioning Products, Inc.