

DESIGNER LINE SANDWICH UNIT

Model: DL36-12M

36" Mighty Top Sandwich Unit Refrigerator with Solid Doors - 12 Pans

Stainless steel exterior and interior.
Certified under NSF-7 to maintain temperatures in 86°F ambient and designed to maintain NSF-7 temperatures in 100°F ambient.



Options and Accessories

(upcharge and lead times may apply)

Stainless steel finished back in lieu of aluminum	Rear-mounted cutting board
Overshelves (single or double)	Flat insulated night cover
Stainless steel shelves	Remote models
Drawers in lieu of doors	Door locks
Additional epoxy-coated steel shelves	Crumb catcher
Automatic, electric condensate evaporator	Top extensions
Modified pan openings	Digital thermometer
Front breathing	Casters
Expansion valve system	

Consult factory for other model configurations, options and accessories.

Continental
 Refrigerator

Toll-Free: 800-523-7138
 Phone: 215-244-1400
 Fax: 215-244-9579

539 Dunksferry Road
 Bensalem, PA 19020
www.continentalrefrigerator.com

Project Name:

Model Specified:

Location:

Item No:

Quantity:

AIA #:

SIS #:

Standard Model Features

REFRIGERATION SYSTEM

- Performance-rated refrigeration system
- Environmentally-safe R-134a refrigerant
- Unique air flow distribution allows pan product to maintain 33° - 41°F
- Automatic, energy saving, non-electric condensate evaporator
- Non-corrosive, plasticized fin evaporator coil
- Easily serviceable, back mounted compressor

CABINET ARCHITECTURE

- 2" non-CFC polyurethane foam insulation
- Spring loaded, self closing doors
- Magnetic snap-in door gaskets
- Heavy-duty, epoxy-coated steel shelves
- 10" deep, full length nylon cutting board
- Insulated lid
- Adjustable 6" stainless steel legs
- Completely enclosed, vented and removable case back

MODEL FEATURES

- (12) 1/6 size non-recessed pans, 4" deep
- Interior hanging thermometer
- Field rehingeable doors

APPROVAL:

Model Specifications

DIMENSIONAL DATA

Net Capacity (cu. ft.)	10.3 (292 cu l)
1/6 Size Pans (4" deep)	12
Width, Overall (in.)	36 (914 mm)
Depth, Overall (in.) (incl. handles & bumpers)	35 (889 mm)
Depth, Body Only (in.) (less doors)	27 1/2 (699 mm)
Depth, Cutting Board (in.)	10 (254 mm)
Height, Overall (in.) (incl. 6" legs)	43 1/4 (1099 mm)
Shelf Area (sq. ft.)	4.6 (.4 sq m)
No. of Shelves	2
No. of Doors	2
Interior Depth (in.)	19 3/8 (492 mm)
Interior Height (in.)	26 1/4 (667 mm)
Interior Width (in.)	32 (813 mm)

REFRIGERANT DATA

Condensing Unit Size (H.P.)	1/5
Capacity (BTU/Hr)*	1620

ELECTRICAL DATA

Voltage (int'l)	115/60/1 (220/50/1)
Fans	2
Total Amps (int'l)	6.3 (3.7)
10 ft. Cord/Plug [attached] (int'l)	Yes (No)

SHIPPING DATA

Weight (lbs.)	254 (115 kg)
Height - Crated (in.)	43 1/4 (1099 mm)
Width - Crated (in.)	43 (1092 mm)
Depth - Crated (in.)	46 (1168 mm)

* Rating @ +25°F evaporator, 90°F ambient

Figures in parentheses reflect metric equivalents rounded to the nearest whole unit.



Equipped with one NEMA-5-15P Plug
(varies by country)

Continental

Refrigerator

Toll-Free: 800-523-7138
Phone: 215-244-1400
Fax: 215-244-9579

539 Dunkserry Road
Bensalem, PA 19020
www.continentalrefrigerator.com

Due to our continued efforts in developing innovative products, specifications subject to change without notice.



Intertek



MADE IN THE U.S.A.

© Copyright 2015. Continental Refrigerator.
A Division of National Refrigeration & Air Conditioning Products, Inc.

Model Plan Views

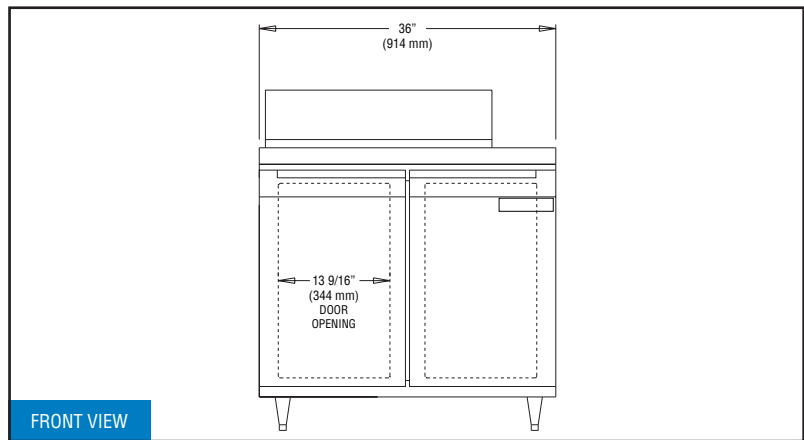

FRONT VIEW

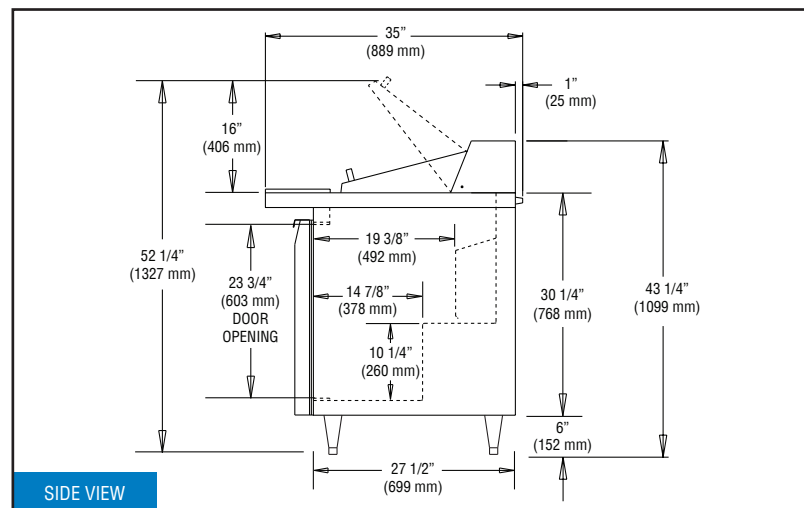

SIDE VIEW

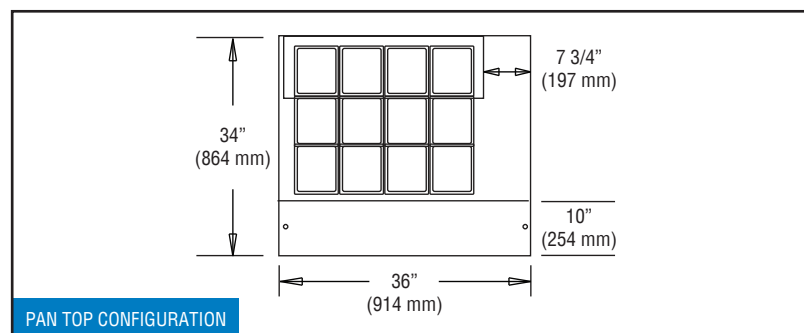

PAN TOP CONFIGURATION

REFRIGERATION SYSTEM

Self-contained refrigeration system is rear mounted, concealed behind a removable louvered cover. A "performancerated", air-cooled, hermetically sealed, capillary type refrigeration system is installed in model. Plasticized finned coil and air circulating fans are contained within an easily accessible rear mounted housing. Unique airflow design allows the cabinet to be enclosed on both sides or mounted flush against a wall. Refrigeration system, fully charged with R-134a refrigerant, is designed to maintain 38°-41°F while operating with an unrestricted air supply in an ambient temperature of 100°F. All condensate water is directed to a non-electric condensate vaporizer located in the compressor compartment, no plumbing is required. A strict quality assurance team inspects all materials and components to certify the model conforms to the most exacting standards. Model is performance tested for a minimum of 16 hours prior to crating.

INSULATION

All cabinet walls, top and bottom have high density, foamed-in-place, non-CFC polyurethane insulation.

CABINET CONSTRUCTION

Materials are top quality, assembled under rigid supervision conforming to strict quality assurance requirements. Case is welded metal construction, internally supported and braced for rigid unit construction. Exterior, interior and worktop are heavy gauge polished stainless steel. Design eliminates overlapping panels with raw edges. Interior corners are rounded with 1/4" radius. Joints and seams are vapor-tight sealed. Easily removable anti-sweat door heaters, concealed by non-metallic, non-conductive, high impact thermal breaker strips, eliminates condensation build-up on case front.

DOOR CONSTRUCTION

Door shells are constructed of heavy-gauge stainless steel and are internally braced and urethane-foam-insulated for rigidity. Door corners are of welded construction and polished. Replaceable snap-in door gaskets are self adjusting, heavy-duty, magnetic type. Door handles and hinges are chrome-plated and non-corrosive. Hinges are spring loaded, heavy duty and self-closing.