

COLD WALL MILK COOLERS

Model: MC5-DCW

58" Cold Wall Milk Cooler Dual Access

White painted steel exterior, stainless steel top and doors, heavy-duty stainless steel lids, door hinges and latches, galvanized steel interior with reinforced stainless steel floor. **Designed to keep milk cold during serving.**



Options and Accessories

(upcharge and lead times may apply)

Stainless steel exterior	Foot pedal floor lock
Stainless steel interior	Color laminate
Wrap around bumpers	Powder coating
Corner bumpers	Single access

Consult factory for other model configurations, options and accessories.

Project Name:

Model Specified:

Location:

Item No:

Quantity:

AIA #:

SIS #:

Standard Model Features

REFRIGERATION SYSTEM

Cold wall, performance-rated refrigeration system

Environmentally-safe R-404A refrigerant

Easily serviceable, bottom-mounted compressor

CABINET ARCHITECTURE

2" high density, non-CFC polyurethane foamed-in-place insulation

Snap-in lids and door gaskets

Non-corrosive, heavy-duty, epoxy-coated steel wire floor racks

Door cylinder security locks

5" swivel casters w/ front locking brakes

MODEL FEATURES

Electronic controller w/digital display & hi-low alarm

Floor drain

Continental[®]
Refrigerator

Toll-Free: 800-523-7138
Phone: 215-244-1400
Fax: 215-244-9579

539 Dunksferry Road
Bensalem, PA 19020
www.continentalrefrigerator.com

APPROVAL:

Model Specifications

DIMENSIONAL DATA

Net Capacity (cu. ft.)	24.0 (680 cu l)
Crate Capacity (13" x 13" x 11")	16
Crate Capacity (19" x 13" x 11")	10
Width, Overall (in.)	58 (1473 mm)
Depth, Overall (in.)	33 (838 mm)
Height, Overall (in.) (incl. 5" casters)	41 1/2 (1054 mm)

REFRIGERANT DATA

Condensing Unit Size (H.P.)	1/3
Capacity (BTU/Hr)*	1930

ELECTRICAL DATA

Voltage (int'l)	115/60/1 (220/50/1)
Total Amps (int'l)	5.6 (3.0)
10 ft. Cord/Plug [attached] (int'l)	Yes (No)

SHIPPING DATA

Weight (lbs.)	580 (263 kg)
Height - Crated (in.)	56 1/4 (1429 mm)
Width - Crated (in.)	67 1/4 (1708 mm)
Depth - Crated (in.)	36 1/2 (927 mm)

* Rating @ +10°F evaporator, 90°F ambient

Figures in parentheses reflect metric equivalents rounded to the nearest whole unit.



Equipped with one NEMA-5-15P Plug
(varies by country)

Model Plan Views

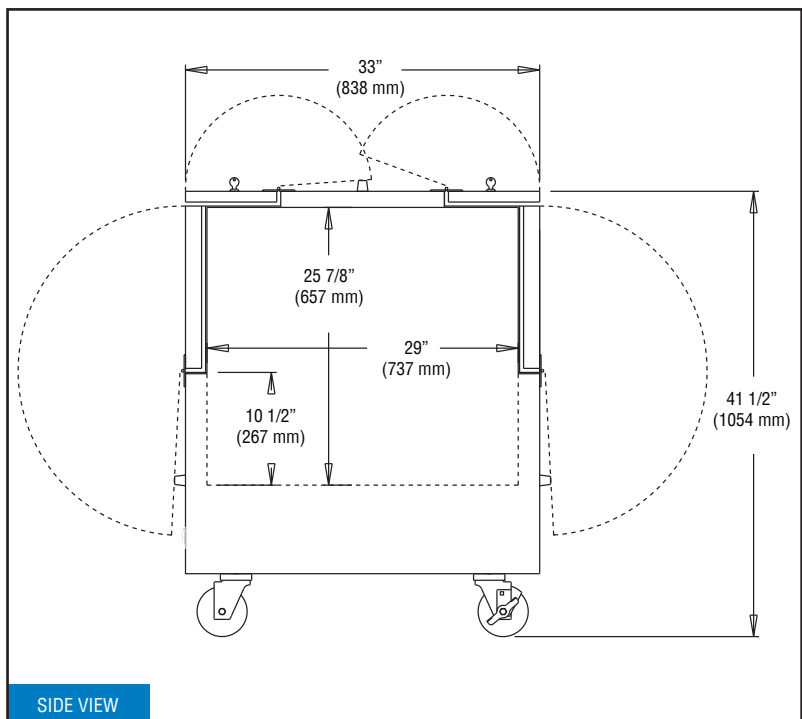
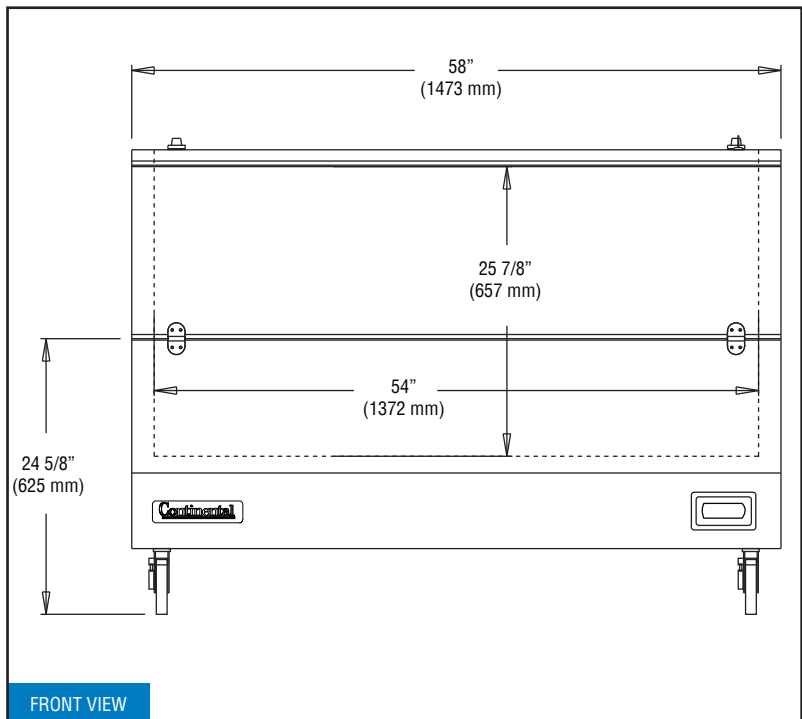

Continental
Refrigerator

Toll-Free: 800-523-7138
Phone: 215-244-1400
Fax: 215-244-9579

539 Dunkserry Road
Bensalem, PA 19020
www.continentalrefrigerator.com

Due to our continued efforts in developing innovative products, specifications subject to change without notice.



MADE IN THE U.S.A.

© Copyright 2018. Continental Refrigerator.
A Division of National Refrigeration & Air Conditioning Products, Inc.