

GRIDDLE STAND REFRIGERATOR

Product Specifications

DL72G - 72" Griddle Stand Refrigerator

All models are front breathing with stainless steel interior and exterior. Easy-glide drawers hold 6" deep pans side-by-side. Rear coil air flow allows even distribution of cold across drawers. Drawers designed to hold up to 250 lb. capacity.



DIMENSIONAL DATA

Net Capacity (cu. ft.)	16.4 (464 cu l)
Width, Overall (in.)	72 (1829 mm)
Depth, Overall (incl. handles) (in.)	34 ³ / ₄ (883 mm)
Height, Overall (incl. 4" casters) (in.)	26 ³ / ₈ (670 mm)
No. of Drawers	4
No. of 12 x 20 x 6 pans (not furnished)	6
No. of 6 x 6 x 6 pans (not furnished)	6

REFRIGERANT DATA

Condensing Unit Size (H.P.)	1/4
Capacity (BTU/Hr)*	1940

ELECTRICAL DATA

Cabinet	115/60/1
Feed Wires (incl. ground)	3
Condensing Unit	115/60/1
Total Amps	6.1
Cabinet Amps	2.2
Power Supply Cord	Yes

SHIPPING DATA

Height - Crated (in.)	44 (1118 mm)
Width - Crated (in.)	90 (2286 mm)
Depth - Crated (in.)	39 (991 mm)
Volume - crated (cu. ft.)	89 (2520 cu l)
Weight - Crated (lbs.)	550 (249 kg)

* Rating @ +25°F evaporator, 90°F ambient
Figures in parentheses reflect metric equivalents.

OPTIONS AND ACCESSORIES

- | | |
|----------------------------------|--|
| • Doors in lieu of drawers | • Adjustable Legs |
| • Cylinder locks | • Remote models |
| • Stainless steel top extensions | • Digital thermometer |
| • Stainless steel pans | • Special electrical requirements
(consult factory) |

Consult factory for other model configurations, options and accessories.

Continental
Refrigerator

Toll-Free: 800-523-7138
Phone: 215-244-1400
Fax: 215-244-9579

539 Dunksferry Road
Bensalem, PA 19020
www.continentalrefrigerator.com

Project Name:

Model Specified:

Location:

Item No:

Quantity:

APPROVAL:

Standard Design Features

REFRIGERATION SYSTEM

Environmentally-safe R-134a refrigerant

CABINET ARCHITECTURE

High density, non-CFC polyurethane foam insulation

Stainless steel interior and exterior

Chrome-plated hardware

Reinforced stainless steel finished work top with drip guard marine edge

Heavy-duty drawer track with built-in safety clips

Drawers designed to hold 250 lb. capacity

4" casters welded on support plates

One piece, snap-in, magnetic gaskets

MODEL FEATURES

Easy glide drawers designed to hold 6" deep pans side-by-side

Capillary dial thermometer

Rear-mounted, automatic, non-electric condensate evaporator

Easily accessible and serviceable front slide-out condensing unit

Front breathing

GRIDDLE STAND REFRIGERATOR

DL72G - 72" Griddle Stand Refrigerator Model Blueprint

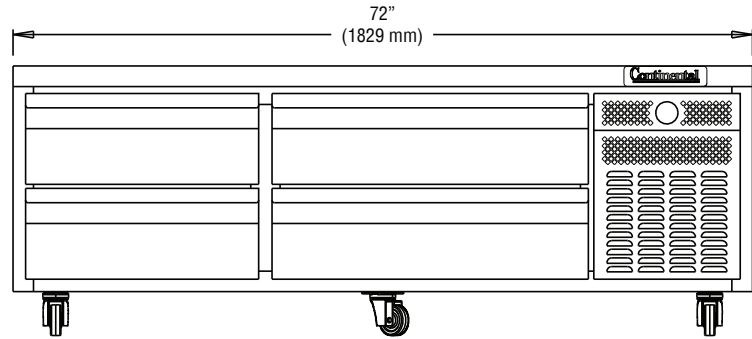

FRONT VIEW

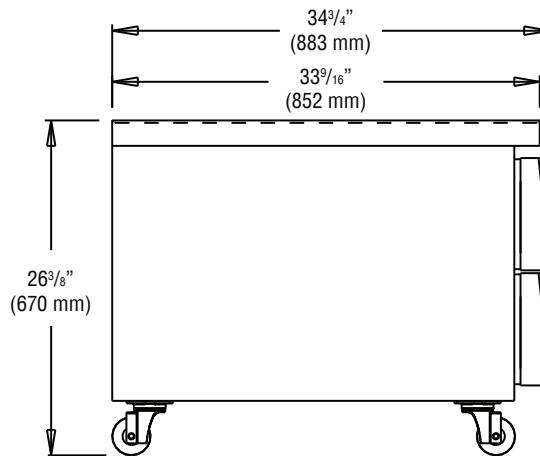

SIDE VIEW



Equipped with one NEMA-5-15P Plug



This Continental Refrigerator product is warranted to be free from all manufacturing defects, material or workmanship, for a period of one (1) year from date of original installation, or fifteen (15) months from date of shipment, whichever occurs first. All motor-compressor assemblies are warranted to be free from defects, material and workmanship, for a period of five (5) years from date of installation.

Due to our continued efforts in developing innovative products, specifications subject to change without notice.



MADE IN THE U.S.A.

© Copyright 2011. Continental Refrigerator.
A Division of National Refrigeration & Air Conditioning Products, Inc.

Continental
Refrigerator

Toll-Free: 800-523-7138
Phone: 215-244-1400
Fax: 215-244-9579

539 Dunksferry Road
Bensalem, PA 19020
www.continentalrefrigerator.com

DL72G (10/5/11)