

FORCED AIR MILK COOLERS

Model: MC4NSSS

Natural Refrigerant R-290 Model

49" Forced Air Milk Cooler Single Access

Stainless steel exterior and interior, heavy-duty stainless steel lid(s), door hinges and latches with reinforced stainless steel floor. **Designed to keep milk cold during serving.**



Options and Accessories

(upcharge and lead times may apply)

Wrap around bumpers	Color laminate
Corner bumpers	Powder coating
Floor foot pedal lock	

Consult factory for other model configurations, options and accessories.

Project Name:

Model Specified:

Location:

Item No:

Quantity:

AIA #:

SIS #:

Standard Model Features

REFRIGERATION SYSTEM

Forced air, performance-rated refrigeration system

Natural, environmentally-safe, high-efficiency R-290 refrigerant¹

Built-in, electric condensate evaporator

Easily serviceable, bottom-mounted compressor

CABINET ARCHITECTURE

2" high density, non-CFC polyurethane foamed-in-place insulation

Snap-in lid and door gasket

Non-corrosive, heavy-duty, epoxy-coated steel wire floor racks

Door cylinder security lock

5" swivel casters w/ front locking brakes

MODEL FEATURES

Electronic controller w/digital display & hi-low alarm

Floor drain

Unique forced air flow curtain

¹ R-290 refrigerant meets all federal and state regulatory requirements.

Continental
Refrigerator

Toll-Free: 800-523-7138
Phone: 215-244-1400
Fax: 215-244-9579

539 Dunksferry Road
Bensalem, PA 19020
www.continentalrefrigerator.com

APPROVAL:

Model Specifications

DIMENSIONAL DATA

Net Capacity (cu. ft.)	20.0 (566 cu l)
Crate Capacity (13" x 13" x 11")	12
Crate Capacity (19" x 13" x 11")	8
Width, Overall (in.)	49 (1245 mm)
Depth, Overall (in.)	33 (838 mm)
Height, Overall (in.) (incl. 5" casters)	47 (1194 mm)

REFRIGERANT DATA

Condensing Unit Size (H.P.)	1/3+
Capacity (BTU/Hr)*	2620

ELECTRICAL DATA

Voltage (int'l)	115/60/1 (220/50/1)
Total Amps (int'l)	7.6 (5.5)
10 ft. Cord/Plug [attached] (int'l)	Yes (No)

SHIPPING DATA

Weight (lbs.)	470 (213 kg)
Height - Crated (in.)	56 1/4 (1429 mm)
Width - Crated (in.)	58 1/4 (1480 mm)
Depth - Crated (in.)	36 1/2 (927 mm)

* Rating @ +25°F evaporator, 90°F ambient

Figures in parentheses reflect metric equivalents rounded to the nearest whole unit.



Equipped with one NEMA-5-15P Plug
(varies by country)

Model Plan Views

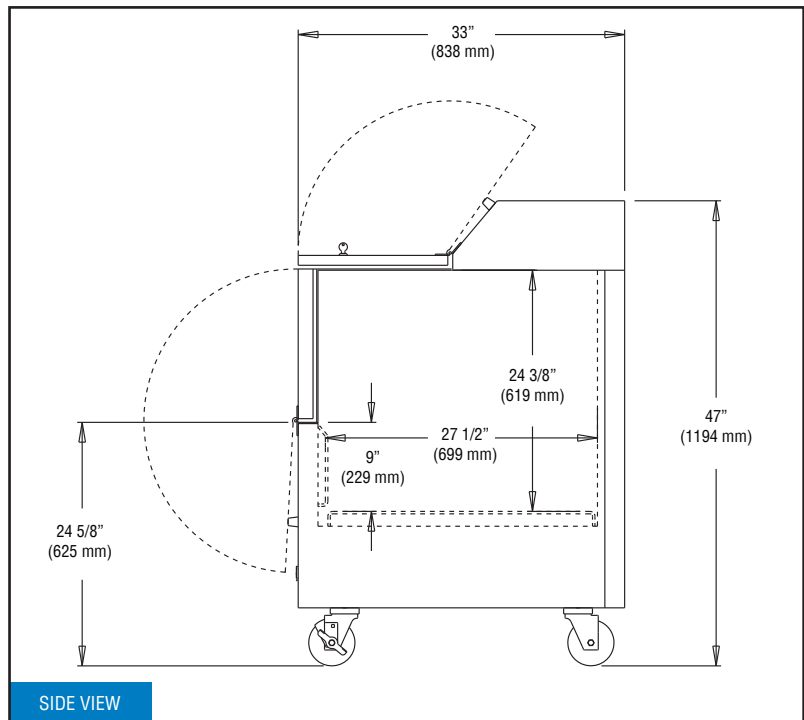
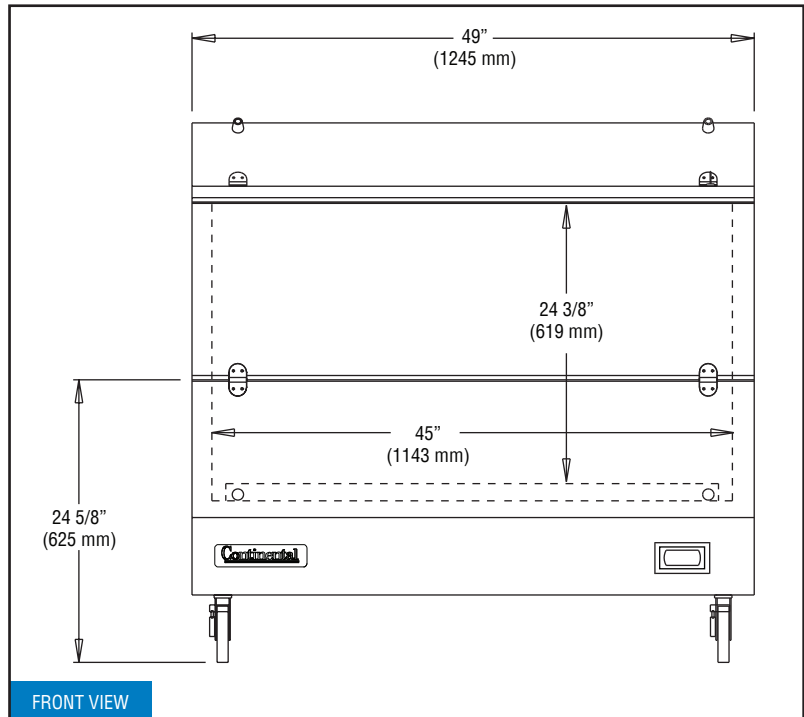

Continental
Refrigerator

Toll-Free: 800-523-7138
Phone: 215-244-1400
Fax: 215-244-9579

539 Dunkserry Road
Bensalem, PA 19020
www.continentalrefrigerator.com

Due to our continued efforts in developing innovative products, specifications subject to change without notice.



MADE IN THE U.S.A.

© Copyright 2019, Continental Refrigerator.
A Division of National Refrigeration & Air Conditioning Products, Inc.