

BASE UNDERCOUNTER REFRIGERATOR

Model: RA68N-U-D

Natural Refrigerant R-290 Model

68" Base Undercounter Refrigerator with Drawers

Heavy gauge #300 Series stainless steel top, stainless steel front and end panels, galvanized steel rear and grill and aluminum interior.



Options and Accessories

(upcharge and lead times may apply)

Stainless steel interior	Door/drawers locks
Stainless steel back	Front breathing
Overshelves (single or double)	Drawer in lieu of door section above the condensing unit*
Adjustable legs	Condensing unit left (standard on right)

Consult factory for other model configurations, options and accessories.

*Drawer section above condensing unit holds (1) 12 x 20 x 6 pan.

Project Name:

Model Specified:

Location:

Item No:

Quantity:

AIA #:

SIS #:

Standard Model Features

REFRIGERATION SYSTEM

Performance-rated refrigeration system

Natural, environmentally-safe, high-efficiency R-290 refrigerant¹

Unique forced air design utilizes fans (approx. every 12") across the entire back of unit for even distribution of cold

Automatic, hot gas condensate evaporator

Non-corrosive, plasticized fin evaporator coil

Easily serviceable, back mounted compressor

Expansion valve system

CABINET ARCHITECTURE

2" non-CFC polyurethane foam insulation

Smooth, polished chrome drawer/door handles

Spring loaded, self closing door (over condensing unit)

Magnetic snap-in drawer/door gaskets

Stainless steel roll-out drawers

Completely enclosed, vented and removable rear and side grills

(8) 1 3/8" diameter plate casters mounted on heavy-duty support plates (easily field installed)

MODEL FEATURES

Electronic controller w/digital display & hi-low alarm

Front breather air divider (field installed)

Electronic control, off-cycle defrost

Refrigerated section w/door above the condensing unit

Field rehingeable door (over condensing unit)

¹ R-290 refrigerant meets all federal and state regulatory requirements.

NOTE: Models come standard with a door over the condensing unit. A drawer over the condensing unit is an option.

Continental
Refrigerator

Toll-Free: 800-523-7138
Phone: 215-244-1400
Fax: 215-244-9579

539 Dunksferry Road
Bensalem, PA 19020
www.continentalrefrigerator.com

APPROVAL:

Model Specifications

DIMENSIONAL DATA

Net Capacity (cu. ft.)	22 (623 cu l)
Width, Overall (in.)	68 3/16 (1732 mm)
Depth, Overall (in.) (incl. handles & bumpers)	36 5/16 (922 mm)
Height, Overall (in.) (incl. 1 3/8" plate casters)	31 3/4 (806 mm)
No. of Drawers	4
No. of Half Doors	1
Interior Depth (in.) (above condenser)	30 (762 mm)
Interior Height (in.) (above condenser)	12 1/2 (318 mm)
Interior Width (in.) (above condenser)	17 (432 mm)

REFRIGERANT DATA

Condensing Unit Size (H.P.)	1/4+
Capacity (BTU/Hr)*	4220

ELECTRICAL DATA

Voltage (int'l)	115/60/1 (220/50/1)
Total Amps (int'l)	4.8 (2.3)
10 ft. Cord/Plug [attached] (int'l)	Yes (No)

SHIPPING DATA

Weight (lbs.)	475 (215 kg)
Height - Crated (in.)	43 3/4 (1111 mm)
Width - Crated (in.)	70 (1778 mm)
Depth - Crated (in.)	47 (1194 mm)

DRAWER PAN CONFIGURATIONS

Two Tier: (2) 12 x 20 x 6 pans per drawer

* Rating @ +25°F evaporator, 90°F ambient
Figures in parentheses reflect metric equivalents rounded to the nearest whole unit.



Equipped with one NEMA-5-15P Plug
(varies by country)

Model Plan Views

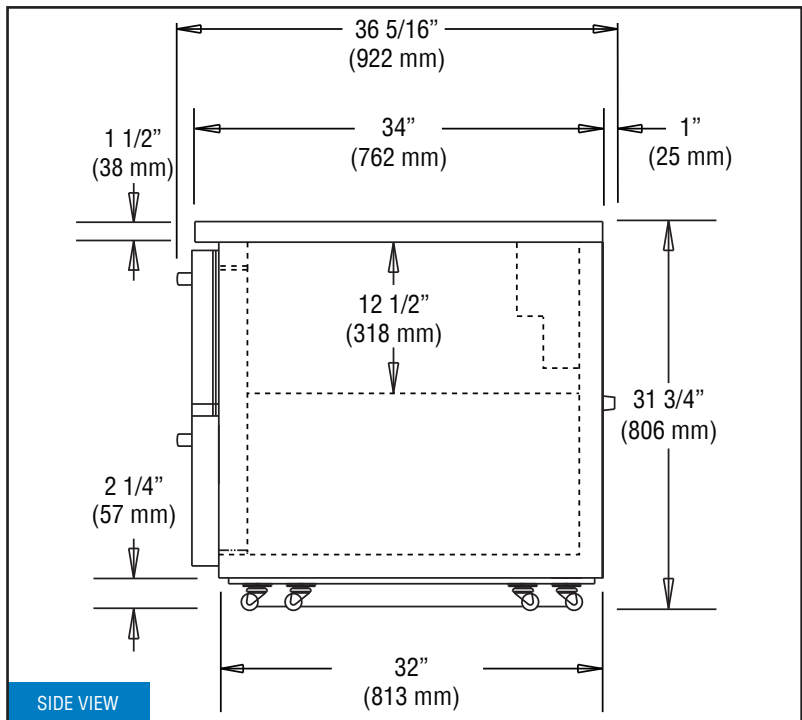
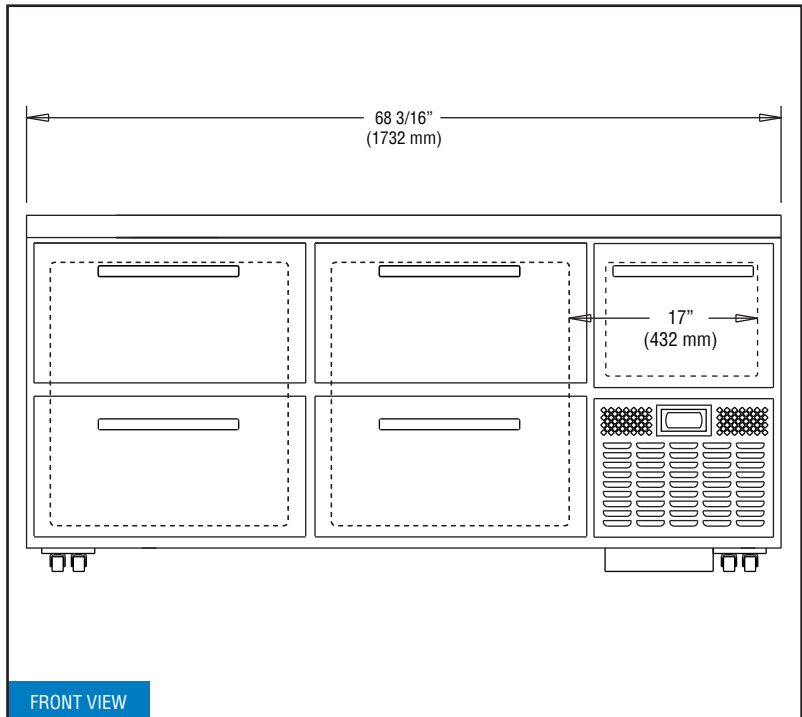

NOTE: For proper operation, the area under and in front of the cabinet **must** not be obstructed in any way.

Continental
Refrigerator

Toll-Free: 800-523-7138
Phone: 215-244-1400
Fax: 215-244-9579

539 Dunkserry Road
Bensalem, PA 19020
www.continentalrefrigerator.com

Due to our continued efforts in developing innovative products, specifications subject to change without notice.



MADE IN THE U.S.A.

© Copyright 2019, Continental Refrigerator.
A Division of National Refrigeration & Air Conditioning Products, Inc.

RA68N-U-D (6/15/19)